

**MERV 11 Deep Pleat Rigid Cell
Furnace Filter
(QFI094)**

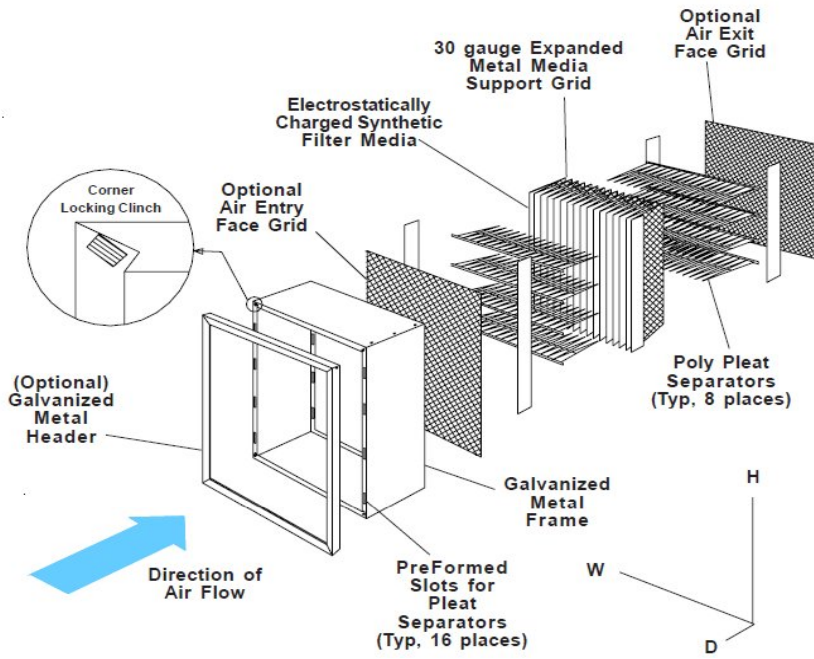

Performance Data - Quality Cell

Product Code	ASHRAE 52.2 - 1999					ASHRAE 52.1 - 1991		
	MERV Value	E1 %	E2 %	E3 %	Initial Resistance "w.g. @ 492 fpm	Final Resistance "w.g. @ 492 fpm	Initial Resistance "w.g. @ 500 fpm	Final Resistance "w.g. @ 500 fpm
MERV 11	11	-	-	-	-	-	0.22	1.50
MERV 12	12	59.6	85.6	95	0.31	1.50	-	-
MERV 13	13	68.8	90.2	95.1	0.41	1.50	-	-
MERV 14	14	75.8	93.9	99.4	0.54	1.50	-	-
MERV 8	8	n/a	n/a	n/a	0.15	1.50	-	-

Nominal Size	Media Area No Header (sq. ft.)	Media Area Header (sq. ft.)	Flow Rate (cfm)	Actual Dimensions
12 x 24 x 6	15	13	500	11.375" x 23.375" x 5.5"
20 x 20 x 6	20	18	694	19.375" x 19.375" x 5.5"
20 x 24 x 6	24	22	833	19.375" x 23.375" x 5.5"
24 x 24 x 6	29	27	1000	23.375" x 23.375" x 5.5"
12 x 24 x 12	29	25	1000	11.375" x 23.375" x 11.5"
20 x 20 x 12	40	38	1389	19.375" x 19.375" x 11.5"
20 x 24 x 12	48	44	1667	19.375" x 23.375" x 11.5"
24 x 24 x 12	58	52	2000	23.375" x 23.375" x 11.5"